

PHARMA LINE

We design and create with passion

TECHNICAL CATALOGUE

Realizzazione in acciaio inox AISI 304 Cr-Ni 18/10

Realization in AISI 304 18/10 chrome-nickel stainless steel

Réalisation en acier inox AISI 304 au nickel-chrome 18/10

Verwirklichung aus rostfreiem Chromnickelstahl AISI 304 18/10

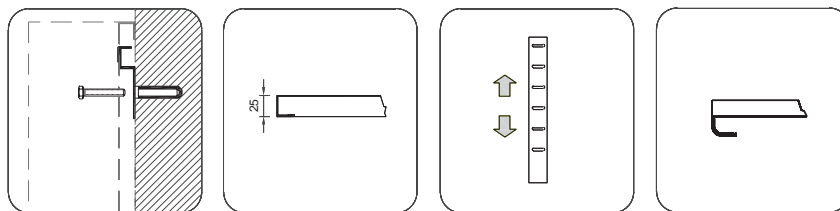

•Wall cupboards •Armoires murales •Hängeschränke

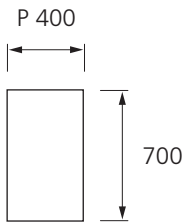

PENSILI ARMADIATI

-in acciaio inox AISI 304 Cr-Ni 18/10
-porte battenti
-ripiano intermedio regolabile
-completo di kit per fissaggio a parete

WALL CUPBOARDS

-in AISI 304 18/10 chrome-nickel stainless steel
-hinged doors
-intermediate and adjustable shelf
-complete of dowels for wall fixing

ARMOIRES MURALES

-en acier inox AISI 304 au nickel-chrome 18/10
-portes battants
-étagère intermédiaire réglable
-complete de chevilles pour le fixation murale

HÄNGESCHRÄNKE

-aus rostfreiem Chromnickelstahl AISI 304 18/10
-Schlagtüren
-regulierbarer Zwischenboden
-komplett mit dubel für die wandmontage

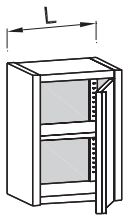

H. 700	
L	Cod.
500	W501 0 0500
500	W501 1 0500

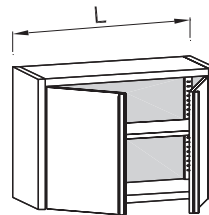

H. 700	
L	Cod.
750	W501 6 0750
1000	W501 6 1000

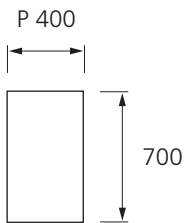

PENSILI AD ANGOLO

-in acciaio inox AISI 304 Cr-Ni 18/10
-a 2 porte battenti
-ripiano intermedio regolabile
-completo di kit per fissaggio a parete

CORNER WALL CUPBOARDS

-in AISI 304 18/10 chrome-nickel stainless steel
-with 2 hinged doors
-intermediate and adjustable shelf
-complete of dowels for wall fixing

ARMOIRES MURALES A ANGLE

-en acier inox AISI 304 au nickel-chrome 18/10
-avec 2 portes battants
-étagère intermédiaire réglable
-complete de chevilles pour le fixation murale

ECKHÄNGESCHRÄNKE

-aus rostfreiem Chromnickelstahl AISI 304 18/10
-mit 2 Schlagtüren
-regulierbarer Zwischenboden
-komplett mit dubel für die wandmontage

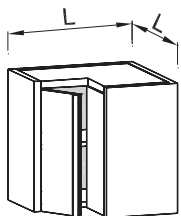

H. 700	
L	Cod.
700	W501 A 0700

PENSILI ARMADIATI

- in acciaio inox AISI 304 Cr-Ni 18/10
- con porte scorrevoli
- ripiano intermedio regolabile
- completo di kit per fissaggio a parete

WALL CUPBOARDS

- in AISI 304 18/10 chrome-nickel stainless steel
- with sliding doors
- intermediate and adjustable shelf
- complete of dowels for wall fixing

ARMOIRES MURALES

- en acier inox AISI 304 au nickel-chrome 18/10
- avec portes coulissantes
- étagère intermédiaire réglable
- complete de chevilles pour le fixation murale

HÄNGESCHRÄNKE

- aus rostfreiem Chromnickelstahl AISI 304 18/10
- mit Schiebetüren
- regulierbarer Zwischenboden
- komplett mit dubel für die wandmontage

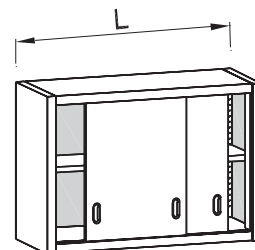
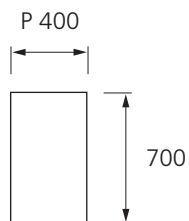

H. 700

L	Cod.	
1000	W506 1 1000	
1100	W506 1 1100	
1200	W506 1 1200	
1250	W506 1 1250	
1300	W506 1 1300	
1400	W506 1 1400	
1500	W506 1 1500	
1600	W506 1 1600	
1700	W506 1 1700	
1750	W506 1 1750	
1800	W506 1 1800	
1900	W506 1 1900	
2000	W506 1 2000	

PENSILI ARMADIATI

- in acciaio inox AISI 304 Cr-Ni 18/10
- con porte scorrevoli in vetro stratificato spess.mm.6
- ripiano intermedio regolabile
- completo di kit per fissaggio a parete

WALL CUPBOARDS

- in AISI 304 18/10 chrome-nickel stainless steel
- with sliding doors in stratified glass thickness 6mm.
- intermediate and adjustable shelf
- complete of dowels for wall fixing

ARMOIRES MURALES

- en acier inox AISI 304 au nickel-chrome 18/10
- avec portes coulissantes en verre stratifié épaisseur 6mm.
- étagère intermédiaire réglable
- complete de chevilles pour le fixation murale

HÄNGESCHRÄNKE

- aus rostfreiem Chromnickelstahl AISI 304 18/10
- mit Schiebetüren aus geschichtetes Glas Stärke 6mm.
- regulierbarer Zwischenboden
- komplett mit dubel für die wandmontage

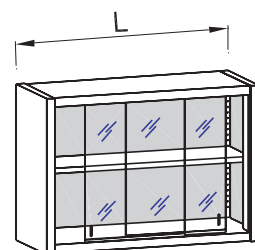
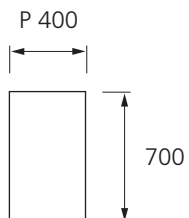

H. 700

L	Cod.	
1000	W506 6 1000	
1100	W506 6 1100	
1200	W506 6 1200	
1250	W506 6 1250	
1300	W506 6 1300	
1400	W506 6 1400	
1500	W506 6 1500	

ACCESSORI: Vedi pag.173

Accessories: See page 173

Accessoires: Voir page 173

Zubehöre: Siehe Seite 173

•Wall cupboards •Armoires murales •Hängeschränke

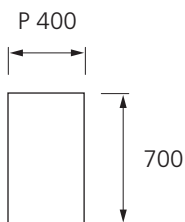

PENSILI SGOCCIOLATOIO

-in acciaio inox AISI 304 Cr-Ni 18/10
-porte battenti
-fondo forato e ripiano intermedio forato
-completo di kit per fissaggio a parete

DRAINER WALL CUPBOARDS

-in AISI 304 18/10 chrome-nickel stainless steel
-hinged doors
-perforated bottom and perforated intermediate shelf
-complete of dowels for wall fixing

ARMOIRES MURALES EGOUTTOIR

-en acier inox AISI 304 au nickel-chrome 18/10
-portes battants
-fond perforé et étagère perforée intermédiaire
-complete de chevilles pour le fixage murale

ABTROPFHÄNGESCHRÄNKE

-aus rostfreiem Chromnickelstahl AISI 304 18/10
-Schlagtüren
-unten Lochboden und zwischen Lochboden
-komplett mit dubel für die wandmontage

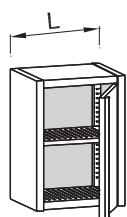

L	Cod.	
500	W511 0 0500	
600	W511 0 0600	
500	W511 1 0500	
600	W511 1 0600	

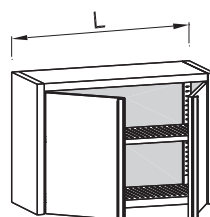

L	Cod.	
700	W511 6 0700	
800	W511 6 0800	

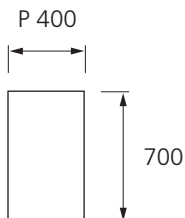

PENSILI SGOCCIOLATOIO

-in acciaio inox AISI 304 Cr-Ni 18/10
-con porte scorrevoli
-fondo forato e ripiano intermedio forato
-completo di kit per fissaggio a parete

DRAINER WALL CUPBOARDS

-in AISI 304 18/10 chrome-nickel stainless steel
-with sliding doors
-perforated bottom and perforated intermediate shelf
-complete of dowels for wall fixing

ARMOIRES MURALES EGOUTTOIRS

-en acier inox AISI 304 au nickel-chrome 18/10
-avec portes coulissantes
-fond perforé et étagère perforée intermédiaire
-complete de chevilles pour le fixage murale

ABTROPFHÄNGESCHRÄNKE

-aus rostfreiem Chromnickelstahl AISI 304 18/10
-mit Schiebetüren
-unten Lochboden und zwischen Lochboden
-komplett mit dubel für die wandmontage

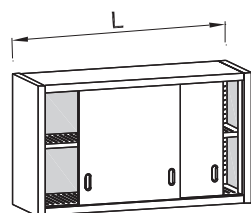

H. 700

L	Cod.	
1000	W516 1 1000	
1200	W516 1 1200	
1400	W516 1 1400	
1600	W516 1 1600	
1800	W516 1 1800	
2000	W516 1 2000	

VASCETTE RACCOGLI ACQUA

-in acciaio inox AISI 304 Cr-Ni 18/10
-per pensili sgocciolatoio

CONTAINERS FOR WATER

-in AISI 304 18/10 chrome-nickel stainless steel
-for drainer wall cupboards

BACS A EAU

-en acier inox AISI 304 au nickel-chrome 18/10
-pour armoires murales égouttoirs

WASSERBEHÄLTERN

-aus rostfreiem Chromnickelstahl AISI 304 18/10
-für Abtropfhängeschränk

- Per pensili sgocciolatoio da:
- For drainer wall cupboards of:
- Pour armoires murales égouttoirs de:
- Für Abtropfhängeschränk von:

L	H	Cod.	
500	30	W590 B 0500	
600	30	W590 B 0600	
700	30	W590 B 0700	
800	30	W590 B 0800	
1000	30	W590 B 1000	
1200	30	W590 B 1200	
1400	30	W590 B 1400	
1600	30	W590 B 1600	
1800	30	W590 B 1800	
2000	30	W590 B 2000	

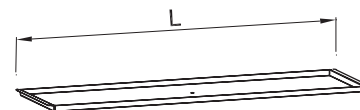

BARRE SOTTOPENSILE FORATE

-in acciaio inox AISI 304 Cr-Ni 18/10

PERFORATED BARS FOR WALL CUPBOARDS

-in AISI 304 18/10 chrome-nickel stainless steel

BARRES PERFOREES SOUS ARMOIRE MURALE

-en acier inox AISI 304 au nickel-chrome 18/10

GELOCHTER STAB FÜR HÄNGESCHRÄNKE

-aus rostfreiem Chromnickelstahl AISI 304 18/10

- Per pensili da:
- For wall cupboards of:
- Pour armoires murales de:
- Für Hängeschränke von:

L	Cod.	
500	W590 C 0500	
600	W590 C 0600	
700	W590 C 0700	
750	W590 C 0750	
800	W590 C 0800	
1000	W590 C 1000	
1100	W590 C 1100	
1200	W590 C 1200	
1250	W590 C 1250	
1300	W590 C 1300	
1400	W590 C 1400	
1500	W590 C 1500	
1600	W590 C 1600	
1700	W590 C 1700	
1750	W590 C 1750	
1800	W590 C 1800	
1900	W590 C 1900	
2000	W590 C 2000	



GANCI

-in acciaio inox AISI 304 Cr-Ni 18/10
-per barre e pannelli forati

HOOKS

-in AISI 304 18/10 chrome-nickel stainless steel
-for perforated bars and panels

CROCHETS

-en acier inox AISI 304 au nickel-chrome 18/10
-pour barres et panneaux perforés

HAKEN

-aus rostfreiem Chromnickelstahl AISI 304 18/10
-für gelochten Stab und Tafel

L	Cod.	
30	590 20 3000	



L	Cod.	
300	590 23 0000	

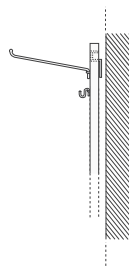
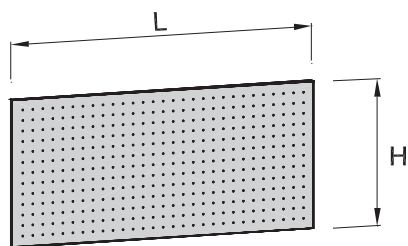

**PANNELLI FORATI**

- in acciaio inox AISI 304 Cr-Ni 18/10
- predisposti per fissaggio a parete con barra
- completo di kit per fissaggio a parete

PERFORATED PANELS

- in AISI 304 18/10 chrome-nickel stainless steel
- for fixing to the wall by bar
- complete of dowels for wall fixing

PANNEAUX PERFORES

- en acier inox AISI 304 au nickel-chrome 18/10
- pour fixage au mur avec barre
- complete de chevilles pour le fixage murale

GELOCHTE TAFELN

- aus rostfreiem Chromnickelstahl AISI 304 18/10
- für Wandbefestigung bei Stab
- komplett mit dubel für die wandmontage

H. 700

L	Cod.	
500	W560 2 0500	
600	W560 2 0600	
700	W560 2 0700	
750	W560 2 0750	
800	W560 2 0800	
900	W560 2 0900	
1000	W560 2 1000	
1100	W560 2 1100	
1200	W560 2 1200	
1250	W560 2 1250	
1300	W560 2 1300	
1400	W560 2 1400	
1500	W560 2 1500	
1600	W560 2 1600	

H. 1000

L	Cod.	
500	W560 3 0500	
600	W560 3 0600	
700	W560 3 0700	
750	W560 3 0750	
800	W560 3 0800	
900	W560 3 0900	
1000	W560 3 1000	
1100	W560 3 1100	
1200	W560 3 1200	
1250	W560 3 1250	
1300	W560 3 1300	
1400	W560 3 1400	
1500	W560 3 1500	
1600	W560 3 1600	



L	Cod.	
30	590 20 3000	

GANCI

- in acciaio inox AISI 304 Cr-Ni 18/10
- per barre e pannelli forati

HOOKS

- in AISI 304 18/10 chrome-nickel stainless steel
- for perforated bars and panels

CROCHETS

- en acier inox AISI 304 au nickel-chrome 18/10
- pour barres et panneaux perforés

HAKEN

- aus rostfreiem Chromnickelstahl AISI 304 18/10
- für gelochten Stab und Tafel



L	Cod.	
30	590 23 0000	

LASTRE AD INCASTRO SU SPONDE

-in acciaio inox AISI 304 Cr-Ni 18/10
-per banchi da lavoro e lavelli

PANELS TO BE FITTED ON BACKPLASHES

-in AISI 304 18/10 chrome-nickel stainless steel
-for work benches and sink units

PANNEAUX A EMBOITER SUR LES DOSSERETS

-en acier inox AISI 304 au nickel-chrome 18/10
-pour tables de travail et plonges

TAFELN FÜR EINBAU IN AUFKANTUNGEN

-aus rostfreiem Chromnickelstahl AISI 304 18/10
-für Arbeitstische und Spültische

H. 750

L	Cod.	
500	W560 1 0500	
600	W560 1 0600	
700	W560 1 0700	
750	W560 1 0750	
800	W560 1 0800	
1000	W560 1 1000	
1100	W560 1 1100	
1200	W560 1 1200	
1250	W560 1 1250	
1300	W560 1 1300	
1400	W560 1 1400	
1500	W560 1 1500	
1600	W560 1 1600	
1700	W560 1 1700	
1750	W560 1 1750	
1800	W560 1 1800	
1900	W560 1 1900	
2000	W560 1 2000	

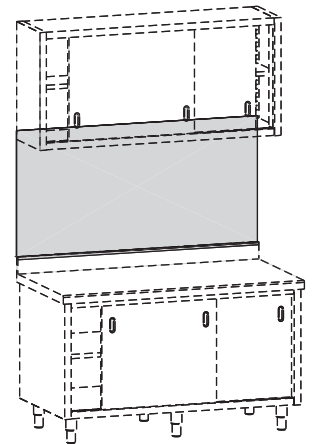
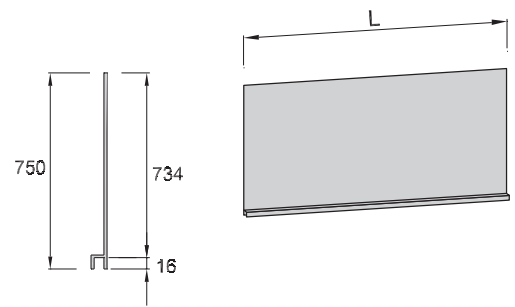

PARETI DIVISORIE

PARETI DIVISORIE

-in acciaio inox AISI 304 Cr-Ni 18/10
-predisposte per fissaggio a parete e pavimento
-piedini regolabili

DIVIDING PANELS

-in AISI 304 18/10 chrome-nickel stainless steel
-predisposed for fixing to wall and floor
-adjustable feet

CLOISONS

-en acier inox AISI 304 au nickel-chrome 18/10
-prédisposées pour fixation à paroi et au sol
-pieds réglables

TRENNWÄNDE

-aus rostfreiem Chromnickelstahl AISI 304 18/10
-veranlagt für die Befestigung an der Wand und am Fußboden
-höhenverstellbare Füße

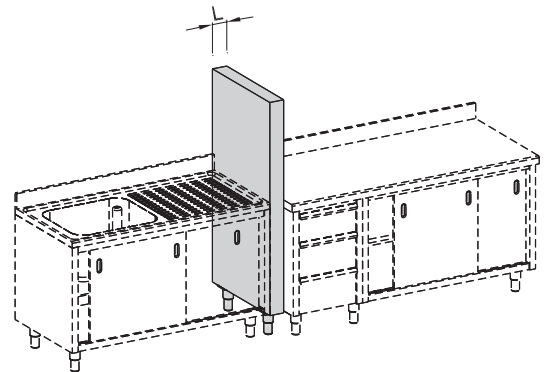
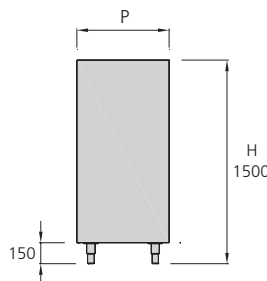

P. 800

L	Cod.	
100	W561 A 0800	

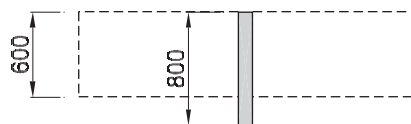

P. 900

L	Cod.	
100	W561 A 0900	

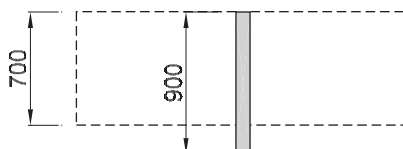

P. 1000

L	Cod.	
100	W561 A 1000	

