

BR 863 095

PremiumLine safety shower combination, with hand-held eye shower, wall mounted, exposed pipework

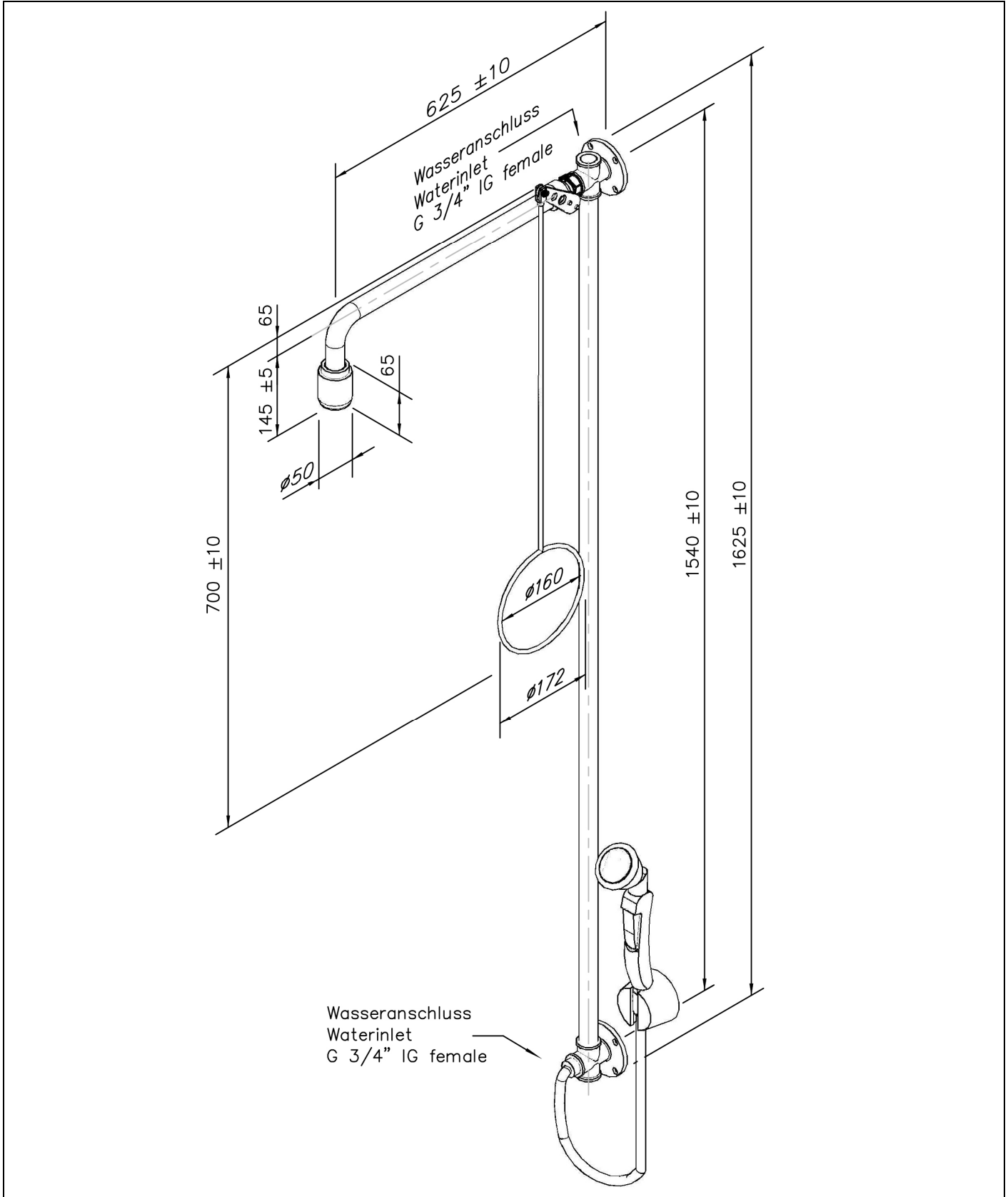

Technical description

PremiumLine safety shower combination, with hand-held eye shower, wall mounted, exposed pipework

- including top and bottom water inlet 3/4" female for installation in circulation lines, plug 3/4" of stainless steel
- wall flange with 4 mounting holes of stainless steel, polished, water inlet 3/4" female
- connection piece of stainless steel, for easy installation and alignment of the shower
- ball valve 3/4" of stainless steel, with quick connect system and pull rod actuation, DIN-DVGW tested and certificated
- pull rod with ring handle of stainless steel, polished, length 700 mm
- wall shower arm 3/4" of stainless steel, polished, projection 630 mm
- integrated automatic flow regulation 50 l/min. for a spray pattern acc. to the norms at a specified operating range of 1.5 to 3 bar dynamic water pressure
- high-performance shower head of stainless steel, polished, with improved spray pattern, corrosion resistant, largely calcification- and maintenance-free, very robust, self-draining
- sign for body safety shower according to EN ISO 7010 und ASR A1.3, self-adhesive PVC-film, 150 x 150 mm, viewing distance 15 metre
- two connection pipes 3/4" of stainless steel, polished, total length 1500 mm
- wall flange with 4 mounting holes of stainless steel, polished, water inlet 3/4" female
- inclusive ClassicLine hand-held eye shower with one spray head 45°, wall mounted
- ergonomically shaped handle with integrated, adjusting activation made of plastics, valve not self-closing
- high-performance spray head for large-scale dispersion of water, 45° angled, with plastic spray plate, largely free of calcification, with rubber sleeves and sealed dust caps with folding mechanism
- integrated flow regulation 7 litre / minute for a standard-compliant jet pattern at a specified working range of 1.5 to 5 bar flow pressure
- integrated backflow preventer to protect the drinking water
- stainless steel covered hose, length 1.5 meter, water inlet 1/2" female, DIN-DVGW tested and certificated
- robust table and wall mounting bracket with positioning of the shower, incl. fastening-parts kit with nut M28x1,5mm and 2 screws M5 for mounting difficult to access, sealing to table surface with O-Ring
- sign for eye shower according to EN ISO 7010 und ASR A1.3, self-adhesive PVC-film, 100 x 100 mm, viewing distance 10 metre
- mounting height 810 mm (± 100 mm)
- according to BGI/GUV-I 850-0, DIN 1988 and EN 1717
- according to ANSI Z358.1-2014, EN 15154-1:2006, EN 15154-2:2006 and EN 15154-5:2019
- DIN-DVGW tested and certificated

Manufacturer: B-SAFETY or equal
 Article-No.: BR 863 095

Technical specifications

Minimum flow pressure:	1.5 bar
Operating pressure:	1.5 to 3 bar
Flow rate body shower:	50 l/min
Flow rate eye shower:	7 l/min
Water inlet:	3/4" female

Norm conformity

- ANSI Z358.1-2014
- EN 15154-1:2006
- EN 15154-2:2006
- EN 15154-5:2019





Approvals

- DIN-DVGW, NW-0416CL0425
- DIN-DVGW, NW-0417CL0263
- GOST-R, Zertifikats-Nr. 0615463



www.b-safety.com

Product overview	
BR 863 095	PremiumLine safety shower combination, with hand-held eye shower, wall mounted, exposed pipework - flow rate 50 l/min (hazard class I according to EN 15154-5:2019)
BR 863 095 / 75L	PremiumLine safety shower combination, with hand-held eye shower, wall mounted, exposed pipework - flow rate 75 l/min / 20 GPM (hazard class II according to EN 15154-5:2019)
BR 863 095 / 110L	PremiumLine safety shower combination, with hand-held eye shower, wall mounted, exposed pipework - flow rate 110 l/min (hazard class III according to EN 15154-5:2019)

Accessories for safety shower combinations

Product overview	Model	Material	Water inlet	Water outlet	Article-No.
	Safety sign "Eye Shower and Safety Shower" Inclusive fastening for mounting on the shower arm. Dimensions: 320 x 180 mm	PVC	-	-	BR 870 100
	Rope release for casualties lying on the floor, in addition to the pull bar.	stainless steel, plastic	-	-	BR 082 200
	Handicapped accessible pull bar with double ring handle, green. Length: 1150 mm	steel	-	-	BR 082 300
	Handicapped accessible pull bar with double ring handle, stainless steel. Length: 1150 mm	stainless steel	-	-	BR 082 350
	Maintenance ball valve for eye showers and safety showers with removable trigger lever.	stainless steel	3/4" female	3/4" male	BR 830 955
	Thermostatic mixing valve for eye showers and safety showers, adjustment range 20 - 43°C, scald protection 43°C, flow rate 60 l/min at 2 bar flow pressure.	brass	3/4" male and 1" male	3/4" male and 1" male	BR 710 950

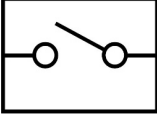
www.b-safety.com

	<p>Flow switch for eye showers and safety showers, protection degree IP 65, electrical supply with 1.5 m cable.</p>	brass	1 1/4" female	1 1/4" female	BR 710 800
	<p>Flow switch for eye showers and safety showers, protection degree IP 65, electrical supply with 1.5 m cable. EX-Zone 1 & 2.</p>	brass	1 1/4" female	1 1/4" female	BR 710 860EX
	<p>Switch for body safety shower alarm, complete pre-assembled on shower. EX-Zone 1 & 2.</p>	plastic	-	-	BR 830 400
	<p>Alarm system for eye showers & safety showers with siren-/flashlight combination. Prewired junction box inclusive electronic switch.</p> <p>Electrical supply: 230 V - 50 Hz</p>	-	-	-	BR 015 800