

www.b-safety.com

BR 834 095

PremiumLine body safety shower with hand-held eye shower with two spray heads 45°, floor mounted

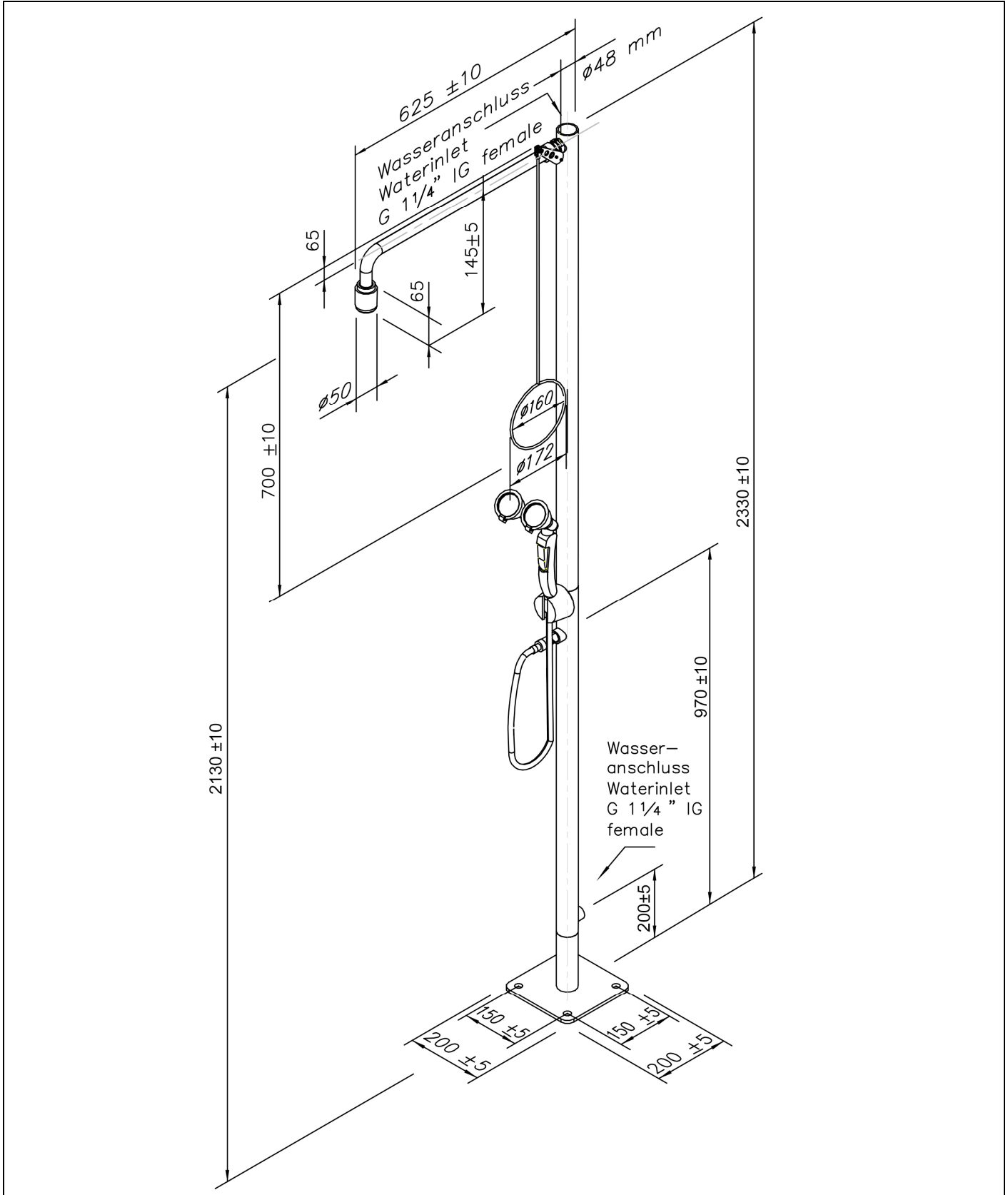

Technical description

PremiumLine body safety shower with hand-held eye shower with two spray heads 45°, floor mounted

- including top and bottom water inlet 1 ¼" female for installation in circulation lines, plug 1 ¼" of stainless steel
- base plate with 4 mounting holes of stainless steel, polished, diameter 200 mm
- stand pipe 1 ¼" of stainless steel three-part, polished, with top and bottom water inlet 1 ¼" female, total height 2330 mm
- connection piece of stainless steel, for easy installation and alignment of the shower
- ball valve ¾" of stainless steel, with quick connect system and pull rod actuation, DIN-DVGW tested and certificated
- pull rod with ring handle of stainless steel, polished, length 700 mm
- wall shower arm ¾" of stainless steel, polished, projection 630 mm
- integrated automatic flow regulation 50 l/min. for a spray pattern acc. to the norms at a specified operating range of 1.5 to 3 bar dynamic water pressure
- high-performance shower head of stainless steel, polished, with improved spray pattern, corrosion resistant, largely scale and maintenance-free, very robust, self-draining
- sign for body safety shower according to EN ISO 7010 und ASR A1.3, self-adhesive PVC-film, 150 x 150 mm, viewing distance 15 metre
- inclusive ClassicLine hand-held eye shower with two spray heads 45°, for mounting on standpipe, position and orientation freely selectable
- ergonomically shaped handle with integrated, adjusting activation made of plastics, valve not self-closing
- high-performance spray heads for large-scale dispersion of water, 45° angled, with plastic spray plate, largely free of calcification, with rubber sleeves and sealed dust caps
- integrated flow regulation 14 litre / minute for a standard-compliant jet pattern at a specified working range of 2 to 5 bar flow pressure
- integrated backflow preventer to protect the drinking water
- stainless steel covered hose, length 1.5 meter, water inlet ½" female, DIN-DVGW tested and certificated
- sturdy wall bracket with positioning of the shower, including mounting kit for mounting on the standpipe
- sign for eye shower according to EN ISO 7010 und ASR A1.3, self-adhesive PVC-film, 100 x 100 mm, viewing distance 10 metre
- according to BGI/GUV-I 850-0, DIN 1988 and EN 1717
- according to ANSI Z358.1-2014, EN 15154-1:20006, EN 15154-2:2006 and EN 15154-5:2019
- DIN-DVGW tested and certificated

Manufacturer: B-SAFETY or equal
 Article-No.: BR 834 095

Technical specifications

Minimum flow pressure:	1.5 bar
Operating pressure:	1.5 to 3 bar
Flow rate body shower:	50 l/min
Flow rate eye shower:	14 l/min
Water inlet:	1 ¼" female
Material:	Stainless steel
Surface:	Polished

Compliance with standards

- EN 15154-1:2006
- EN 15154-2:2006
- EN 15154-5:2019
- ANSI Z358.1-2014

Approvals



- DIN-DVGW, DVGW, NW-0416CL0425
- DIN-DVGW, DVGW, NW-0417CL0263
- GOST-R, Zertifikats-Nr. 0615463

www.b-safety.com

Material overview	Material	Material description
High-performance shower head:	stainless steel	AISI 316
Ball valve:	stainless steel	AISI 316
Flow regulator:	plastic POM	-
Piping:	stainless steel	AISI 316
Pull rod with ring handle:	stainless steel	AISI 316
T-pieces, sleeve, plug:	stainless steel	AISI 316
Base plate:	stainless steel	AISI 316
Sign for body safety shower:	PVC-foil	-
Hand-held eye shower:	plastic Luran	-
Media-carrying parts of the hand-held eye shower:	brass, dezincification resistant (DZR)	CW724R (Ecobrass)
Covered hose of hand-held eye shower:	stainless steel, brass, plastic TPSiV	AISI 304, CW617N
Flow regulator eye shower:	plastic POM	-
Spray head eye shower:	plastic POM, EPDM	-
Sign for eye shower for eye shower:	PVC-foil	-



Product overview	
BR 834 095	PremiumLine body safety shower with hand-held eye shower with two spray heads 45°, floor mounted - flow rate 50 l/min (hazard class I according to EN 15154-5:2019)
BR 834 095 / 75L	PremiumLine body safety shower with hand-held eye shower with two spray heads 45°, floor mounted - flow rate 75 l/min / 20 GPM (hazard class II according to EN 15154-5:2019)
BR 834 095 / 110L	PremiumLine body safety shower with hand-held eye shower with two spray heads 45°, floor mounted - flow rate 110 l/min (hazard class III according to EN 15154-5:2019)

Accessories for industrial safety showers

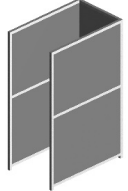
Product overview	Model	Material	Water inlet	Water outlet	Article-No.
	Safety sign "Eye Shower and Safety Shower" Inclusive fastening for mounting on the shower arm. Dimensions: 320 x 180 mm	PVC	-	-	BR 870 100
	Platform actuation for eye showers and safety showers, in addition to the standard actuation.	steel, galvanised	-	-	BR 870 200
	Platform actuation for eye showers and safety showers, in addition to the standard actuation.	stainless steel	-	-	BR 870 205

	Maintenance ball valve for eye showers and safety showers with removable trigger lever.	stainless steel	1 1/4" female	1 1/4" male	BR 830 950
	Thermostatic mixing valve for eye showers and safety showers, adjustment range 20 - 43°C, scald protection 43°C, flow rate 60 l/min at 2 bar flow pressure.	brass	3/4" male and 1" male	3/4" male and 1" male	BR 710 950
	Flow switch for eye showers and safety showers, protection degree IP 65, electrical supply with 1.5 m cable.	brass	1 1/4" female	1 1/4" female	BR 710 860
	Flow switch for eye showers and safety showers, protection degree IP 65, electrical supply with 1.5 m cable. EX-Zone 1 & 2.	brass	1 1/4" female	1 1/4" female	BR 710 860EX
	Switch for body safety shower alarm, complete pre-assembled on shower. EX-Zone 1 & 2.	plastic	-	-	BR 830 400
	Switch for eye shower alarm, complete pre-assembled on shower. EX-Zone 1 & 2.	plastic	-	-	BR 830 450
	Alarm system for eye showers & safety showers with siren-/flashlight combination. Prewired junction box inclusive electronic switch. Electrical supply: 230 V - 50 Hz	-	-	-	BR 015 800
	Anti-scald valve, switching points: open at 41°C, close at 35°C.	stainless steel	1/2" female	1/2" female	BR 830 970
	Frost protection valve, switching points: open at 1°C, close at 4°C.	stainless steel	1/2" female	1/2" female	BR 830 980
	Connection adapter 1 1/4", T-piece, for connection of the protection valves before the safety shower water connection.	stainless steel	1 1/4" female	1 1/4" male 1/2" male	BR 830 986
	Catch basin of stainless steel, with a GRP step grate for eye showers and safety showers. Dimensions: 1100 x 1100 x 150 mm	stainless steel, GRP	-	1 1/4" male	BR 830 700
	Housing for safety showers with a stainless steel frame and stainless steel side walls. Dimensions: 2450 x 1100 x 1100 mm	stainless steel	-	-	BR 830 905

www.b-safety.com

	<p>ANSI flange for eye showers and safety showers, B16.5, 150 LBS, form RF. Inclusive double nipple to 1 1/4" male.</p>	<p>stainless steel AISI 316</p>	<p>ANSI-flange 1 1/4"</p>	<p>1 1/4" male</p>	<p>BR 014 114</p>
	<p>DIN flange for eye showers and safety showers, PN 10, with mounting. Inclusive double nipple to 1 1/4" male.</p>	<p>stainless steel AISI 316</p>	<p>DIN-flange 1 1/4"</p>	<p>1 1/4" male</p>	<p>BR 016 114</p>